

**NOTES:**

1. INSTALLATION TO BE COMPLETED PER MANUFACTURER'S SPECIFICATION.
2. REFER TO TREXFENCINGFDS.COM FOR CONSTRUCTION DETAILS AND PRODUCT INFORMATION.
3. DRAWING NOT TO SCALE.

COMPONENT		QTY	LENGTH
Post Cap		1	N/A
Post	5" x 5"	0.5	144"
Top Rail	4" x 5"	1	91"
L-Channel Vertical Rail	3/4"x1 1/2"	2	71.25"
Bottom Rail / Picket	1" x 5 3/4"	8	91"
Aluminum Top Rail	2 5/8" x 4 5/8"	1	86"
Aluminum Bottom Rail	2 3/4" x 5 1/8"	1	90 1/2"
Fence Bracket	1 1/4" x 3 1/8"	4	N/A
#10 Pan Head Screw		12	3/4"
#7 Ext. Wood Screw		18	1 5/8"
#10 Self Drilling Screws		2	2"

Component lengths may vary

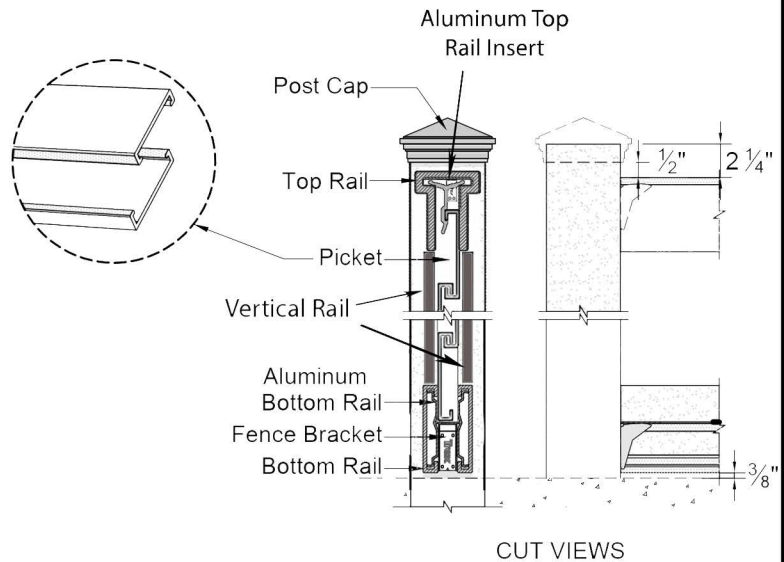

CUT VIEWS

092524